



# MN5048DIY User Manual

---

## Hybrid Inverter / Charger User Manual



# MN5048DIY



# MN5048DIY User Manual

---

## Important safety instructions

### Please keep this manual for future use.

**The MNS Hybrid Inverter System is an all-in-one solution for 120 volt AC production, battery charging from the AC input and a built-in MPPT PV Charge Controller**

This manual contains all safety, installation and operating instructions for the MNS Hybrid Inverter.

Please read all instructions and precautions in the manual carefully before installation and use.

- High voltages exist inside the MNS Hybrid Inverter. To avoid personal injury, users shall not disassemble the MNS Hybrid Inverter themselves. Contact our Midnite Solar technical support department if the unit is a need for repair.
- Do not install the MNS Hybrid Inverter in harsh environments such as moist, oily, flammable, explosive, or heavily dusty areas. The unit is not rain-proof, do not install outside unless under cover where it will not be exposed to rain.
- The mains input and AC output are high AC voltage, do not touch the wiring terminals.
- The housing of the MNS Hybrid Inverter is hot when it is operating especially under full load. The exposed heatsink may be very hot, do not touch.
- Do not open the terminal protective cover when the MNS Hybrid Inverter is operating.
- It is necessary to install a proper external circuit breaker on the 120V AC in and PV in connections. The unit has an internal circuit breaker on the 120V AC in but an external circuit breaker is required in addition.
- Always turn off all combiners and AC circuit breakers of the PV array, AC mains & battery before installing and/or adjusting the wiring of the MNS Hybrid Inverter.
- After installation, check that all wire connections are tight to avoid terminal heating due to poor and a loose connection, which is dangerous and may cause fires.
- The MNS Hybrid Inverter is for off-grid only. DO NOT Connect the AC OUTPUT to any source of AC including GRID and GENERATOR.



# MN5048DIY User Manual

## CONTENTS

<b>1. GENERAL INFORMATION</b>	<b>4</b>
1.1 PRODUCT OVERVIEW AND FEATURES	4
1.2 BASIC SYSTEM INTRODUCTION	5
1.3 APPEARANCE	6
<b>2. INSTALLATION INSTRUCTIONS</b>	<b>7</b>
2.1 INSTALLATION PRECAUTIONS	7
2.2 WIRING SPECIFICATIONS AND CIRCUIT BREAKER SELECTION	8
2.3 INSTALLATION AND WIRING	11
<b>3. OPERATING MODES</b>	<b>17</b>
3.1 CHARGING MODE	17
3.2 OUTPUT MODE	18
<b>4. LCD SCREEN OPERATING INSTRUCTIONS</b>	<b>19</b>
4.1 OPERATION AND DISPLAY PANEL	19
4.2 SETUP PARAMETERS DESCRIPTION	22
4.3 BATTERY TYPE PARAMETERS	28
<b>5. OTHER FUNCTIONS</b>	<b>29</b>
5.1 DRY NODE	30
5.2 USB COMMUNICATION PORT	30
<b>6. PROTECTION</b>	<b>31</b>
6.1 PROTECTIONS PROVIDED	31
6.2 FAULT CODE MEANING	33
6.3 TROUBLESHOOTING	34
<b>7. SYSTEM MAINTENANCE</b>	<b>35</b>
<b>8. TECHNICAL PARAMETERS</b>	<b>36</b>
<b>9. WARRANTY</b>	<b>39</b>



# MN5048DIY User Manual

---

## 1. General information

### 1.1 Product overview and features

DIY series is a new all-in-one hybrid solar charger/inverter, which integrates battery MPPT solar & AC input charging with sine wave output. Thanks to DSP control and advanced control algorithm, it has fast response speed, high reliability and high industrial standards.

Four charging modes are available, i.e. Only Solar, Mains Priority, Solar Priority and Mains & Solar hybrid charging; and two output modes are available, i.e. Inverter and Mains, to meet different application requirements.

The solar charging module applies the latest optimized MPPT technology to quickly track the maximum power point of the PV array in any environment and obtain the maximum energy of the solar panel in real time.

Through a state of the art control algorithm, the AC-DC charging module realizes fully digital voltage and current double closed loop control, with high control precision in a small volume. Wide AC voltage input range and complete input/output protections are designed for stable and reliable battery charging and protection.

Based on full-digital intelligent design, the DC-AC inverter module employs advanced SPWM technology and outputs pure sine wave to convert DC into AC. It is ideal for AC loads such as household appliances, power tools, industrial equipment, and electronic audio and video equipment. The product comes with a segment LCD display design which allows real-time display of the operating data and status of the system. Comprehensive electronic protections keep the entire system safer and more stable.

### **Features:**

1. Full digital voltage and current double closed loop control, advanced SPWM technology, pure sine wave output.
2. Two output modes: mains bypass and inverter output; uninterrupted power supply.
3. Available in 4 charging modes: Only Solar, Mains Priority, Solar Priority and Mains & Solar hybrid charging.
4. Advanced MPPT technology with an efficiency of 99%.
5. Designed with a LCD screen and 3 LED indicators for dynamic display of system data and operating status.
6. ON/OFF rocker switch for AC output control.
7. Power saving mode available to reduce no-load loss.
8. Intelligent variable speed fan to efficiently dissipate heat and extend system life.
9. Battery charging using PV solar or AC input, supporting use of lead-acid and lithium battery technologies.
10. 360 ° all-round protection with a number of protection functions.
11. Complete protections, including short circuit protection, over voltage and under voltage protection, overload protection, reverse protection, etc.

## 1.2 Basic system introduction

The figure below shows the system application scenario of this product. A complete system consists of the following parts:

1. PV module: Converts light energy into DC power, and charges the battery through the onboard MPPT solar charge controller, or to directly drive the inverter making AC power to drive the loads. (battery-less mode)
2. Mains or generator: Connected at the AC input, to power the loads while charging the battery. If the mains or generator is not connected, the system can also operate normally, and the load is powered by the battery and PV array.
3. Battery: Provided to ensure normal power supply to the system loads when solar energy is insufficient and the AC Main is not connected.
4. Household load: Allow connection of various household and office loads, including refrigerators, lamps, TVs, fans and air conditioners.
5. MNS Hybrid Inverter: The energy conversion unit of the whole system. Specific system wiring method depends on the actual application scenario.

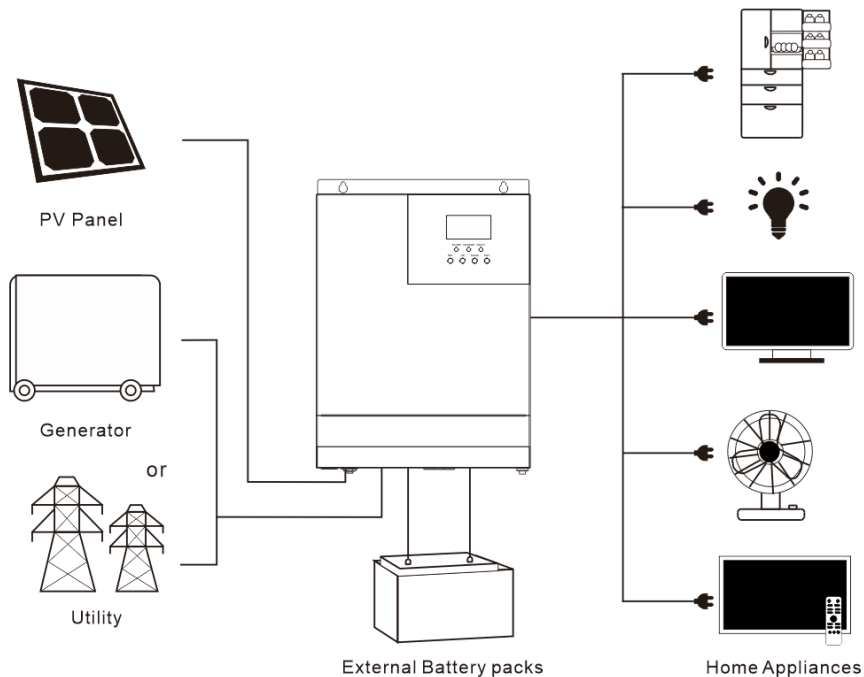

## 1.3 Appearance

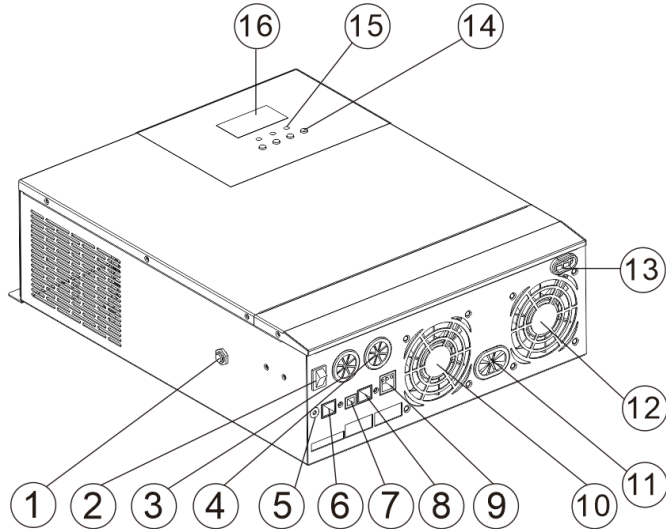

①	Overload protector	⑨	Dry contact port
②	ON/OFF rocker switch	⑩	Cooling fan
③	AC input port	⑪	Battery port
④	AC output port	⑫	Cooling fan
⑤	Grounding screw hold	⑬	PV port
⑥	RS485-2/CAN communication port	⑭	Touch the key lightly
⑦	USB communication port	⑮	Indicator light
⑧	RS485-1 communication port	⑯	LCD screen



# MN5048DIY User Manual

---

## 2. Installation Instructions

### 2.1 Installation precautions

- Be very careful when installing the battery. Wear safety glasses when installing a lead-acid flooded battery. If you come into contact with the battery acid, rinse with clean water immediately.
- Do not place metal objects near the battery to prevent short-circuit of the battery terminals.
- Hydrogen gas may be generated when the battery is charging. Please ensure \ good ventilation.
- When installing the unit, be sure to leave enough space around the MNS Hybrid Inverter for proper heat dissipation. Do not install the MNS Hybrid Inverter and lead-acid battery(s) in the same cabinet to avoid corrosion by sulfuric acid gas generated during battery operation.
- Only batteries that meet the requirements of the MNS Hybrid Inverter can be charged.
- Poorly connected connections and corroded wires may cause terminal heating which could melt the wire insulation, burn the surrounding materials, and even cause fires. So, make sure the terminals have been tightened, and the wires are secured with ties to avoid loose connections caused by shaking of wires during mobile applications.
- Avoid mounting in direct sunlight and where rainwater may get inside if mounting outside..
- Even after the power is turned off, there is still high voltage inside the unit. Do not open or touch the internal components, and avoid related operations until the capacitor completely discharges.
- Do not install the MNS Hybrid Inverter in harsh environments such as moist, oily, flammable or explosive, or heavily dusty areas.
- Do NOT reverse polarity at the battery input terminals, otherwise it may damage the device and/or cause a fire.
- The mains AC input and AC output are high voltage, so please do not touch the wiring terminals.
- Keep fingers and tools away from the fan, do not touch it to prevent injury.



# MN5048DIY User Manual

## 2.2 Wiring specifications and circuit breaker selection

Wiring and installation must comply with national and local electrical codes.

Recommended PV array wiring specifications and circuit breaker selection: Since the output current of the PV array is affected by the type, connection method and illumination angle of the PV module, the minimum wire diameter of the PV array is calculated according to its short circuit current; refer to the short-circuit current value in the PV module specification (the short-circuit current is constant when the PV modules are connected in series; the short-circuit current is the sum of the short circuit currents of all PV modules connected in parallel); the short circuit current of the PV array shall not exceed the maximum input current.

➤ Refer to the table below for PV input wire diameter and switch:

Models	Recommended PV wiring diameter	Maximum PV input current	Recommended circuit breaker type
MN5048DIY	10 AWG	18A	MNEPV20 or MNEDC20

Note: The voltage in series shall not exceed the maximum PV input open circuit voltage.





# MN5048DIY User Manual

> Refer to the table below for recommended AC input wire diameter and switch:

Models	Recommended AC input wiring diameter	Maximum bypass input current	Recommended circuit breaker type
MN5048DIY	6 AWG	63A	MNEAC60

Note: There is already an appropriate circuitbreaker at the Mains input wiring terminal, so it is not necessary to add one more.

> Recommended battery input wire diameter and switch selection

Models	Recommended battery wiring diameter	Rated battery discharge current	Maximum charge current	Recommended circuit breaker type
MN5048DIY	2 AWG	125A	80A	MNEDC125



# MN5048DIY User Manual

➤ Recommended AC output wiring specifications and circuit breaker selection

Models	Recommended AC output wiring diameter	Rated inverter AC output current	Maximum bypass output current	Recommended circuit breaker type
MN5048DIY	6 AWG	42A	63A	MNEAC60

**Note:** The wire gauge is for reference only. If the distance between the PV array and the MNS Hybrid Inverter or the distance between the MNS Hybrid Inverter and the battery is relatively long, using a bigger gauge wire can reduce the voltage drop to improve system performance.

**Note:** The above are only recommended wire gauge and circuit breaker. Please select the appropriate wire gauge and circuit breaker according to actual installation requirements.

Note: Breakers are there to protect the wire not the electronics. Select wire size for the application, and then select breakers for the wire size. All MidNite Solar breakers are rated for continuous duty.

Recommended wire gauge and breaker size.

Max Current	Wire gauge and breaker size	Recommended MidNite Breaker	
20 Amps	12 AWG – 20 Amp Breaker	MNEDC20	MNEPV20
25 Amps	10 AWG – 30 Amp Breaker	MNEDC30	MNEPV30
30 Amps	10 AWG – 30 Amp Breaker	MNEDC30	MNEPV30
40 Amps	8 AWG – 50 Amp Breaker	MNEDC40	MNEPV40
50 Amps	8 AWG – 50 Amp Breaker	MNEDC50	MNEPV50
60 Amps	6 AWG – 60 Amp Breaker	MNEDC60	MNEPV60
125 Amps	2 AWG – 125 Amp Breaker	MNEDC125	-

MNEPV Breakers are dinrail mount and fit in the MNDC125 enclosure.



# MN5048DIY User Manual

## 2.13 Installation and wiring

### Installation steps:

Step 1: Determine the installation position and the space for heat dissipation. Determine the installation position of the MNS Hybrid Inverter, such as wall surface; when installing the MNS Hybrid Inverter, ensure that there is enough air flowing through the heat sink, and space of at least 200mm/8 inches to the left and right air outlets of the inverter are open to ensure natural convection heat dissipation. Refer to the installation diagram of the unit as above.



**Warning:** Danger of explosion! Never install the MNS Hybrid Inverter and lead-acid batteries in the same confined space! Also do not install in a confined place where battery gas may collect.

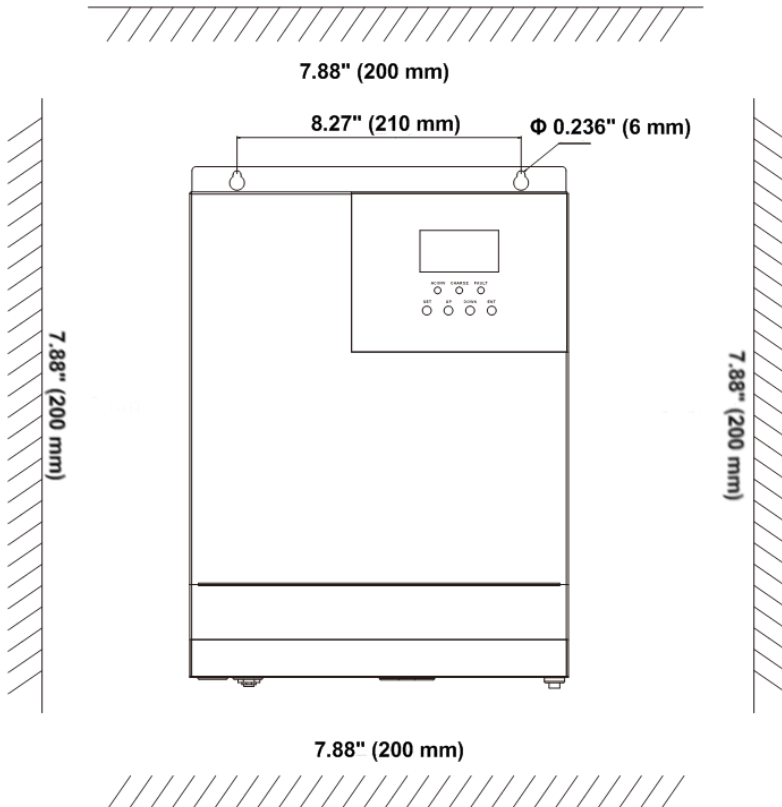

Step 2: Remove the terminal cover

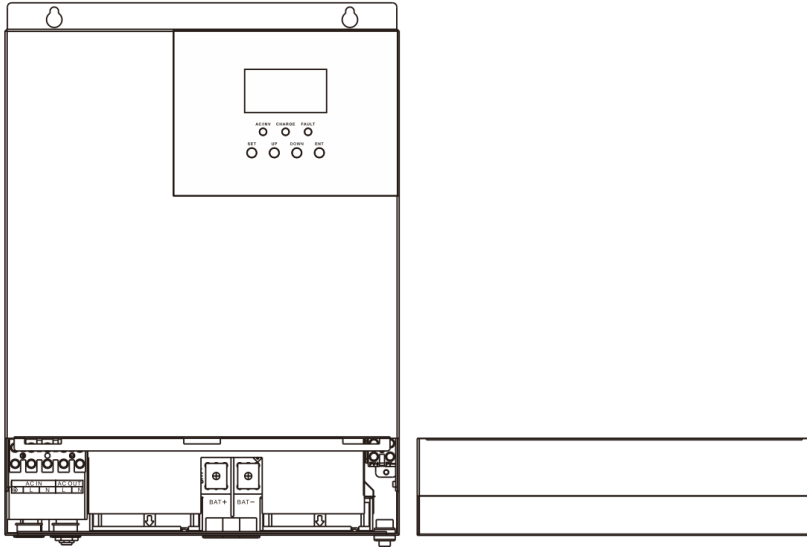

Step 3: Wiring

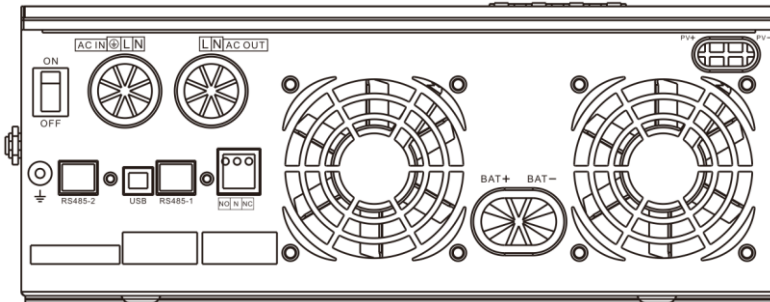

**AC input / output wiring method:**

- ① Prior to AC input/output wiring, disconnect the external circuit breaker and confirm that the wire used is the appropriate AWG. Please refer to Section 2.2 on pg. 8 “Wiring Specifications and Circuit Breaker Selection”.
- ② Properly connect the AC input wire according to the wire sequence and terminal position shown in the figure on the next page. Please connect the ground wire first, and then the hot wire and then the neutral wire.

⏏ : Ground    L : Live    N : Neutral

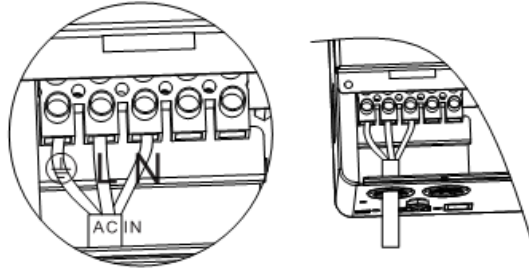

③ Properly connect the AC output wire according to the wire sequence and terminal position shown in the figure below. Please connect the ground wire first, and then the hot wire and the neutral wire. The ground wire is connected to the grounding screw hole on the cabinet using a ring terminal or copper lug.

⏏ : Ground    L : Live    N : Neutral

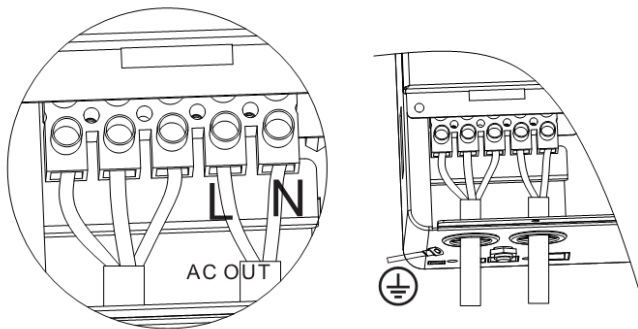

Note: The grounding wire shall be as large as possible (Not less than 10 AWG).  
The grounding point shall be as close as possible to the MNS Hybrid Inverter  
The shorter the grounding wire, the better.



# MN5048DIY User Manual

PV input wiring method:

- ① Prior to wiring, disconnect the external circuit breaker and confirm that the wire used is appropriate AWG. Please refer to Section 2.2 “Wiring Specifications and Circuit Breaker Selection”;
- ② Properly connect the PV input wire according to the wire sequence and terminal position shown in the figure below.

PV+: PV input positive pole

PV -: PV input negative pole

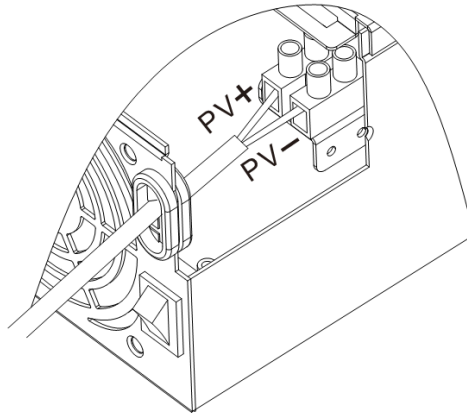

## **BATTERY wiring:**

- ① Prior to wiring, disconnect the external circuit breaker and confirm that the wire used is appropriate AWG. Please refer to Section 2.2 “Wiring Specifications and Circuit Breaker Selection”. The BAT wire needs to be connected to the MNS Hybrid Inverter using a copper ring terminal either setscrew or crimp type is acceptable. Insure the crimp is tight if using crimp style to prevent excessive heat generation caused by excessive contact resistance from a loose terminal;
- ② Properly connect the BAT wire according to the wire sequence and terminal position shown in the figure on the next page.



# MN5048DIY User Manual

BAT +: Battery positive electrode

BAT -: Battery negative electrode

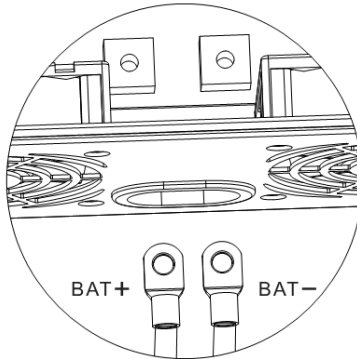

## Warnings:

- ① Mains input, AC output and PV array are all high voltage. So, before wiring, be sure to disconnect the appropriate circuit breaker.
- ② Be very careful during DC wiring; do not close the circuit breaker during wiring, and ensure that the “+” and “-” pole leads of each component are connected properly; a circuit breaker must be installed at the battery input terminals.

Refer to Section 2.2 on pg. 9 “Wiring Specifications and Circuit Breaker Selection” to select a correct circuit breaker. Before wiring, be sure to disconnect the circuit breaker to prevent strong electric sparks and avoid battery short circuit; if the MNS Hybrid Inverter is used in an area with frequent lightning, it is recommended to install an external surge suppressors at the PV input terminal as well as the AC input and output. The MNSPD300DC is the correct model for the PV input and the MNSPD300AC for the AC input and output. Both sold separately

**Step 4:** Check if the wiring is correct and tight. In particular, check if the battery polarity is reversed, if the PV input polarity is reversed and if the AC input is properly connected.

Step 5: Install the terminals cover.

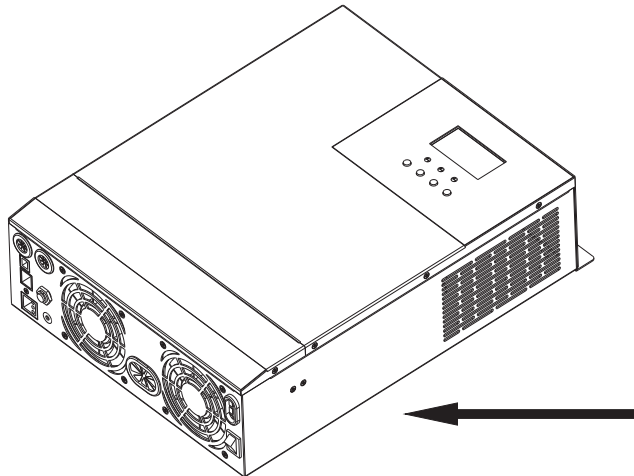
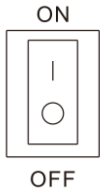

### Step 6: Turn on the MNS Hybrid Inverter

First, close the circuit breaker at the battery terminal, and then turn the rocker switch on the left side of the machine to the "ON" position. The "AC/INV" indicator flashing indicates that the inverter is working normally. Close the circuit breakers of the PV array and the AC Mains.

Finally, turn on AC loads one by one to avoid overcurrent caused by a large momentary load from turning on loads all at once. Now, the unit goes into normal operation.

**Note:** If power is supplied to different AC loads, it is recommended to first turn on the load with a large surge current. After the load is stable, turn on the load with a small surge current.

**Note:** If the MNS Hybrid Inverter does not work properly or the **LCD** indicator is abnormal, refer to Chapter 6 to handle the error.



## 3. Operating modes

### 3.1 Charging mode

- 1) PV priority: PV module will charge the battery preferentially, and the battery is charged by the Mains only when the PV system fails. During the day, solar energy is fully used to charge, while at night, it reverts to the Mains. This can maintain battery level, and is ideal for areas where the grid is relatively stable and electricity price is relatively high.

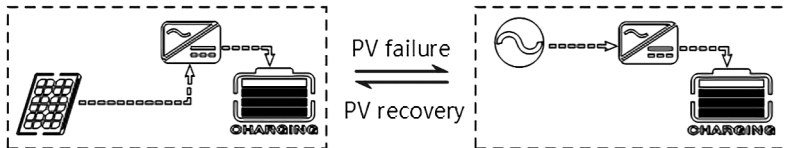

- 2) Mains priority: The Mains supply is preferentially used to charge the battery. Only when the Mains are not available, the PV charging will be activated.

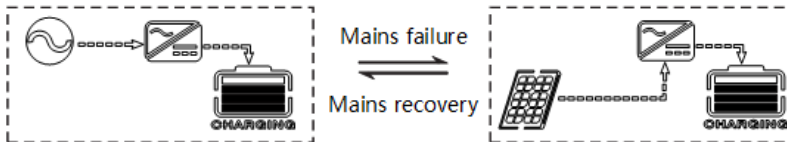

- 3) Hybrid charging: PV and mains hybrid charging. PV MPPT charging is a priority, and when PV energy is insufficient, the mains supply supplements. When the PV energy is sufficient again, the mains stop charging. This is the fastest charging mode, suitable for the areas where the power grid is unstable, providing sufficient backup power supply at any time.

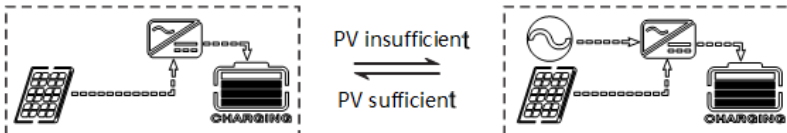

- 4) Only Solar (Only Solar): Only PV charging, without Mains charging. This is the most energy efficient way in which the battery is charged, and is usually used in areas with good lighting conditions.

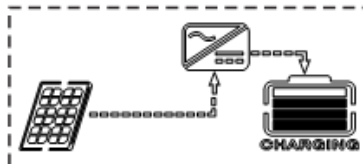

## 3.2 Output mode

- PV priority mode: Loads are powered by the PV module and battery. Diversified charging mode and output mode are optional. When PV priority mode is selected, utilization of green solar energy can be maximized to achieve energy saving and emission reduction.  
Switch to mains supply when the PV charging is not available. This mode maximizes the use of solar energy while maintaining battery power, suitable for use in the areas with relatively stable grid.

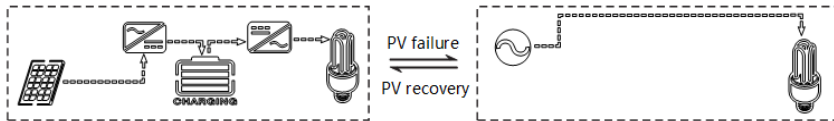

- Mains priority mode: Switch to inverter only when the mains are not available. Then, the unit is equivalent to a backup UPS, suitable for areas with unstable grid.

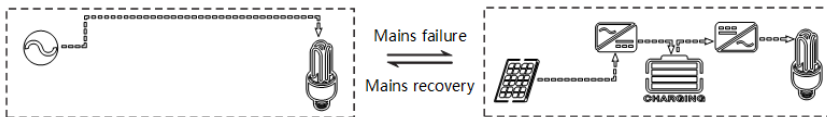

- Inverter priority mode: Switch to mains supply only when the battery is under voltage. This mode maximizes the use of DC power and is best suited for areas with a stable grid.

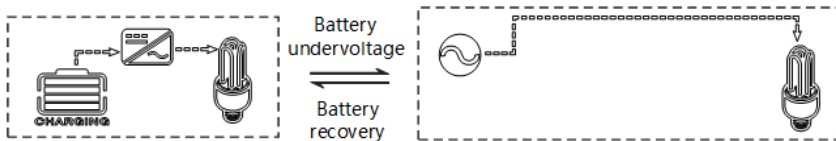

- Mixed loading mode: when the battery is fully charged, the battery no longer needs to be charged. At this time, the load is provided by the photovoltaic and the commercial power. Photovoltaic maximum power output is not enough to be supplemented by the utility

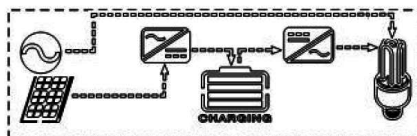

## 4. LCD screen operating instructions

### 4.1 Operation and display panel

The operation and display panel is as shown below, including 1 LCD screen, 3 indicators and 4 operation buttons.

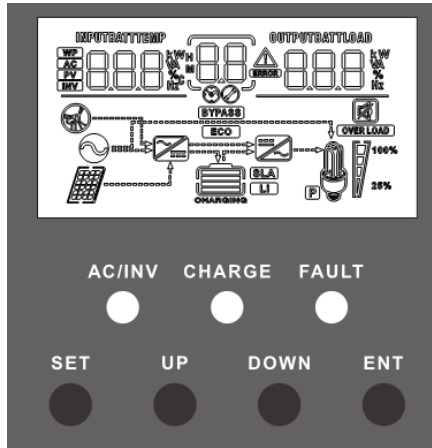

#### Operation buttons introduction

Function buttons	Description
SET	Enter/Exit Settings menu
UP	Previous choice
DOWN	Next choice
ENT	Confirm /Enter Options under the settings menu,

#### Indicators introduction





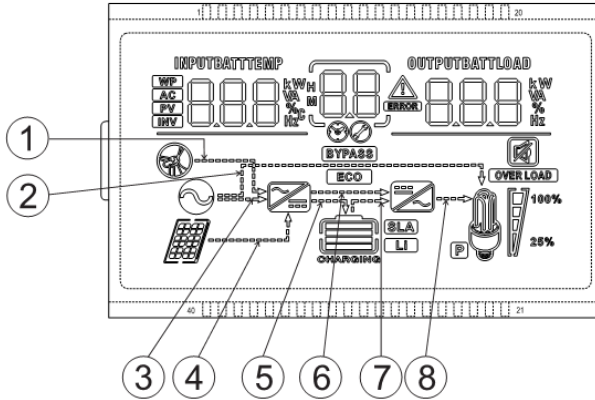









Indicators	Colors	Description
AC/INV	Yellow	Steady on : Mains output
		Flash: Inverter output
CHARGE	Green	Flash: Battery charging
		Steady on : Charging completed
FAULT	Red	Steady on : Fault state

## LCD screen introduction



Icons	Functions	Icons	Functions
	Indicates that the AC input terminal has been connected to the grid		Indicates that the inverter circuit is working
	Indicates that the AC input mode in APL mode (wide voltage range)		Indicates that the machine is in the Mains Bypass mode
	Indicates that the PV input terminal has been connected to the solar panel		Indicates that the AC output is in an overload state
	Indicates that the machine has been connected to the battery: indicates that the remaining battery is 0%~24% ; indicates that the remaining battery is 25%~49% ; indicates that the remaining battery is 50%~74% ; indicates that the remaining battery is 75%~100% .		Indicates the percentage of AC output loads: indicates that the load percentage is 0%~24% ; indicates that the load percentage is 25%~49%, indicates that the load percentage is 50%~74%, indicates that the load percentage is ≥ 75%.
	Indicates that the battery type of the machine is a lithium battery		Indicates that the buzzer is not enabled

# MN5048DIY User Manual

	Indicates that the current battery type of the unit is a lead acid - battery		Indicates that the unit has an alarm
	Indicates that the battery is in charging state		Indicates that the unit is in a fault condition
	Indicates that the AC/PV charging circuit is working		Indicates that the unit is in setup mode
	Indicates that the AC output terminal has an AC voltage output		The parameters displayed in the middle of the screen : 1. In the non-setup mode, the alarm or fault code is displayed. 2. In the set up mode, the currently set parameter item code is displayed.
Parameters display on the left side of the screen: input parameters			
	Indicates AC input		
	Indicates PV input		
	Indicates inverter circuit		
	This icon is not displayed		
	Display battery voltage, battery charge total current, mains charge power, AC input voltage, AC input frequency, PV input voltage, internal heatsink temperature, software version		
Parameters display on the right side of the screen: Output parameters			
	Indicates output voltage, output current, output active power, output apparent power, battery discharge current, software version; in setup mode, displays the set parameters under the currently set parameter item code		
Arrow display			
①	The arrow is not displayed	⑤	Indicates the charging circuit charging the battery terminal
②	Indicates the grid is supplying power to the load	⑥	The arrow is not displayed
③	Indicates the grid supplying power to the charging circuit	⑦	Indicates the battery terminal supplying power to the inverter circuit
④	Indicates PV module supplying power to the charging circuit	⑧	Indicates the inverter circuit supplying power to the load



# MN5048DIY User Manual

Real-time data viewing method

On the LCD main screen, press the “ UP” and “ DOWN ” buttons to scroll through the real-time data of the machine.

Page	Parameters on the left side of the screen	Parameters in the middle of the screen	Parameters on the right side of the screen
1	INPUT BATT V (Battery input voltage )	Fault code	OUTPUT LOAD V (Output load voltage )
2	PV TEMP °C (PV charger heatsink temperature )		PV OUTPUT KW (PV output power)
3	PV INPUT V (PV input voltage )		PV OUTPUT A (PV output current )
4	INPUT BATT A (Input battery current )		OUTPUT BATT A (Battery output current)
5	INPUT BATT KW (Battery input power)		OUTPUT BATT KW (Battery output power)
6	AC INPUT Hz (AC input frequency)		AC OUTPUT LOAD Hz (AC output frequency )
7	AC INPUT V (AC input voltage )		AC OUTPUT LOAD A (AC output load current )
8	INPUT V (For maintain )		OUTPUT LOAD KVA (Load apparent power)
9	INV TEMP °C (AC charge or battery discharge heatsink temperature )		INV OUTPUT LOAD KW (Load active power )
10	APP software version		Bootloader software version
11	Model PV Voltage Rating		Model PV Current Rating
12	Model Battery Voltage Rating		Model Output Power Rating

## 4.2 Setup parameters description

Buttons operation instructions: Press the “SET” button to enter the setup menu and exit the setup menu. After entering the setup menu, the parameter number [00] will flash. At this point, press the “UP” and “DOWN” buttons to select the code of parameter item to be set. Then, press the “ENT” button to enter the parameter editing mode, and the value of the parameter is flashing. Adjust the value of the parameter with the “UP” and “DOWN” buttons. Finally, press the “ENT” button to complete the parameter editing and return to the parameter selection state.



# MN5048DIY User Manual

Parameter no.	Parameter name	Settings	Description
00	Exit setting menu	[00] ESC	Exit the setup menu
01	Output source priority	[01] SOL	PV priority mode, switching to the Mains when the PV fails or the battery is lower than the set value of parameter [04].
		[01] UTI default	Mains priority mode, switching to inverter only when the mains fail .
		[01] SBU	Inverter priority mode, switching to the mains only when the battery is under voltage or lower than the set value of parameter [04].
02	Output Frequency	[02] 50.0	Bypass self-adaptation; when the mains are connected, it automatically adapts to the mains frequency; when the mains iare disconnected, the output frequency can be set through this menu. The default output frequency of the 230V machine is 50HZ, and the 120V machine 60HZ.
		[02] 60.0	
03	AC Input Voltage Range	[03] APL	Wide mains input voltage range of 230V machine: 90~280V Mains input voltage range of 120V machine: 90~140V
		[03] UPS default	Narrow mains input voltage range of 230V machine: 170~280V Mains input voltage range of 120V machine: 90~140V
04	Battery Power to Utility Setpoint	[04] 46.0 default	When the parameter [01] =SOL/SBU, the battery voltage is lower than the set value, and the output is switched from the inverter to the mains. Setting range: 44V - 52V.
05	Utility to Battery Power Setpoint	[05] 56.0V default	When the parameter [01] =SOL/SBU, the battery voltage is higher than the set value, and the output is switched from the mains to the inverter. Setting range: 48V~60V.



# MN5048DIY User Manual

Parameter no.	Parameter name	Settings	Description
06	Charger source priority	[06] CSO	PV priority charging ; when not PV is unavailable, charging from the mains is started.
		[06] CUB	Mains priority charging; When charging from the mains is not available PV charging is started.
		[06] SNU default	PV and Mains hybrid charging; PV charging is a priority, and when the PV energy is insufficient, the Mains charging supplements. When the PV energy is sufficient, the Mains charging stops. Note: Only when the Mains bypass output is loaded, the PV charging and the mains charging can work at the same time. When the inverter is in use, only the PV charging can be started.
		[06] OSO	Only PV charging, with the Mains charging not activated.
07	Max charger current	[07] 60A default	Max charger current (AC charger+PV charger). Setting range: 0~80A
08	Battery Type	[08] USE	User-defined ; all battery parameters can be set.
		[08] SLd	Sealed lead - acid battery; absorption charge Voltage: 57.6V, float charge voltage: 55.2V
		[08] FLd	Vented lead-acid battery; absorption charge voltage: 58.4V, float charge voltage: 55.2V
		[08] GEL default	Colloidal lead- acid battery; absorption charge voltage: 56.8V float charge voltage: 55.2V
		[08] LL14/L15/L16	Lithium iron phosphate battery L14/L15/L16 corresponds to lithium iron phosphate battery 14 strings/15 strings/16 strings;16 string/15 string/14 string default constant The charging voltage is 56.8V, 53.2V, 49.6V, which are adjustable.





# MN5048DIY User Manual

Parameter no.	Parameter name	Settings	Description
		[08] N13/N14	Ternary lithium battery; which is adjustable.
09	Battery Absorption charge voltage	[09] 57.6V default	Boost (absorb) charge voltage setting; the setting range is 48~58.4V with a step of 0.4V for user-defined battery and lithium battery.
10	Battery Absorption charge time	[10] 120 default	Boost (absorb) charge maximum time setting, which means the maximum charging time to reach the set voltage of parameter [09] during constant-voltage charging. The setting range is 5min~900min, with a step of 5 minutes. It is valid for user -defined battery and lithium battery.
11	Battery float charge voltage	[11] 55.2V default	Float charge voltage, setting range: 48V~58.4V at 0.4V step is valid in for a user-defined battery.
12	Battery over discharge voltage (delay off)	[12] 42V default	Over-discharge voltage ; when the battery voltage drops to the set point, after the delay time set by parameter [13] the inverter will stop inverting. Setting range is 48V - 58.4V with a step of 0.4V. It is valid for user - defined battery and lithium battery.
13	Battery over discharge delay time	[13] 5S default	Over-discharge delay time; when the battery voltage is lower than the parameter [12], the inverter output will be turned off after the time set by this parameter is delayed. The setting range is 5S~55S, with a step of 5S. It is valid for user-defined battery and lithium battery.
14	Battery under voltage alarm	[14] 44V default	Battery undervoltage alarm point ; when the battery voltage is lower than the point, an undervoltage alarm is given , and the output is not turned off; the setting range is 48V ~ 52V with a step of 0.4V. It is valid for user -defined battery and lithium battery .



# MN5048DIY User Manual

Parameter no.	Parameter name	Settings	Description
15	Battery discharge limit voltage	[15] 40V default	Battery discharge limit voltage; when the battery voltage is lower than the point, the output is turned off immediately; the setting range is 40V~52V, with a step of 0.4V. It is valid for user -defined battery and lithium battery.
16	Battery equalization enable	[16] DIS	Equalizing charge is disabled
		[16] ENA default	Equalizing charge is enabled, only valid for vented lead-acid battery and sealed lead-acid battery
17	Battery equalization voltage	[17] 58.4V default	Equalizing charge voltage; setting range : 48V~58.4V, with a step of 0.4V; valid for vented lead-acid battery and sealed lead-acid battery
18	Battery equalized time	[18] 120 default	Equalizing charge time ; setting range : 5min~900min, with a step of 5 minutes; valid for vented lead-acid battery and sealed lead-acid battery
19	Battery equalized time out	[19] 120 default	Equalizing charge delay ; setting range : 5min~900min, with a step of 5 minutes ; valid for vented lead-acid battery and sealed lead-acid battery
20	Battery equalization interval	[20] 30 default	Equalizing charge derating time, 0~30days, with a step of 1 day ; valid for vented lead-acid battery and sealed lead-acid battery
21	Battery equalization immediately	[21] DIS	Stop equalizing charge immediately.
		[21] ENA default	Start equalizing charge immediately.
22	Power saving mode	[22] DIS default	Power saving mode disabled .
		[22] ENA	When the power saving mode is enabled, if there is no load or less than 50W, the inverter output is turned of f after a delay for a certain period of time. When the load is more than 50W, the inverter automatically restarts.
23	Restart when over load	[23] DIS	Automatic restart when overload is disabled. If an overload occurs and the output is turned off, the unit will not restart .



# MN5048DIY User Manual

Parameter no.	Parameter name	Settings	Description
24	Restart when over temperature	[24] DIS	Auto matic restart when over temperature is disabled. If an over-temperature shutdown occurs, machine will not restart to turn the output on.
		[24] ENA default	Automatic restart when over temperature is enabled. If an over-temperature shutdown occurs, the machine will restart when the temperature drops.
25	Alarm enable	[25] DIS	Alarm is disabled
		[25] ENA default	Alarm is enabled
26	Beeps while primary source is interrupted	[26] DIS	Alarm beep is disabled when the status of the main input source changes
		[26] ENA default	Alarm beep is enabled when the status of the main input source changes
27	Bypass output when over load	[27] DIS	It is disabled to automatically switch to the Mains when the inverter is overloaded.
		[27] ENA default	It is enabled to aut omatically switch to the Mains when the inverter is overloaded.
28	Max AC charger current	[28] 40A default	Max AC charger current. Setting range: 0~40A ;
29	Split Phase	[29] DIS default	Supply for industrial frequency transformer (disabled )
		[29] ENA	Supply for industrial frequency transformer (enabled )
30	Rs485 address setting	[35] 1 default	Rs485 communication address setting range 1 ~ 254, (refer to Number [32] is valid when set as SLA)
35	Battery undervoltage recovery point	[35] 50.4V default	When the battery voltage is under voltage, the battery voltage needs to recover more than this set value before the inverter starts the output
36	Max PV charger current	[36] 40A default	Max PV charger current. Setting range: 0~40A
37	Battery fully charged recovery point	[37] 52V default	After the battery is fully charged, it needs to be lower than this set voltage before it can be recharged



# MN5048DIY User Manual

## 4.3 Battery type parameters

For Lead -acid Battery :

Battery type Parameters	Sealed lead acid battery (SLD)	Colloidal lead acid battery (GEL)	Vented lead acid battery (FLD)	User - defined (User)
Overvoltage disconnection voltage	60V	60V	60V	36 ~ 60V
Equalizing charge voltage	58.4V	56.8V	59.2V	36 ~ 60V
Absorption charge voltage	57.6V	56.8V	58.4V	36 ~ 60V (Adjustable)
Float charge voltage	55.2V	55.2V	55.2V	36 ~ 60V (Adjustable)
Undervoltage alarm voltage	44V	44V	44V	36 ~ 60V (Adjustable)
Low voltage disconnection voltage	42V	42V	42V	36 ~ 60V (Adjustable)
Discharge limit voltage	40V	40V	40V	36 ~ 60V (Adjustable)
Over -discharge delay time	5s	5s	5s	1 ~ 30s (Adjustable)
Equalizing charge duration	120 minutes	-	120 minutes	0 ~ 600 minutes (Adjustable)
Equalizing charge interval	30 days	-	30 days	0 ~ 250 days (Adjustable)
Absorption charge duration	120 minutes	120 minutes	120 minutes	10 ~ 600 minutes (Adjustable)



# MN5048DIY User Manual

For Lithium Battery :

Battery type Parameters	Ternary lithium battery (N 13)	Ternary lithium battery (N 14)	Lithium iron phosphate battery (LF16)	Lithium iron phosphate battery (LF15)	Lithium iron phosphate battery (LF14)	User - defined (User)
Overvoltage disconnection voltage	60V	60V	60V	60V	60V	36 ~ 60V
Absorption charge voltage	53.2V (Adjustable)	57.6V (Adjustable)	56.8V (Adjustable)	53.2V (Adjustable)	49.2V (Adjustable)	36 ~ 60V (Adjustable)
Floating charge voltage	53.2V (Adjustable)	57.6V (Adjustable)	56.8V (Adjustable)	53.2V (Adjustable)	49.2 (Adjustable)	36 ~ 60V (Adjustable)
Undervoltage alarm voltage	43.6V (Adjustable)	46.8V (Adjustable)	49.6V (Adjustable)	46.4V (Adjustable)	43.2V (Adjustable)	36 ~ 60V (Adjustable)
Low voltage disconnection voltage	38.8V (Adjustable)	42V (Adjustable)	48.8V (Adjustable)	45.6V (Adjustable)	42V (Adjustable)	36 ~ 60V (Adjustable)
Discharge limit voltage	36.4V	39.2V	46.4V	43.6V	40.8V	36 ~ 60V (Adjustable)
Over-discharge delay time	30s (Adjustable)	30s (Adjustable)	30s (Adjustable)	30s (Adjustable)	30s (Adjustable)	1 ~ 30s (Adjustable)
Absorption charge duration	120 minutes (Adjustable)	120 minutes (Adjustable)	120 minutes (Adjustable)	120 minutes (Adjustable)	120 minutes (Adjustable)	10 ~ 600 minutes (Adjustable)

## 5. Other functions

### 5.1 Dry contact

Working principle: This dry contact can start and stop the generator to charge the battery. ① Normally, the terminals are that the NC-N point is closed and the NO -N point is open; ② When the battery voltage reaches the low voltage disconnection point, the relay coil is energized, and the terminals turn to that the NO-N point is closed while NC-N point is open. At this point, NO-N point can drive resistive loads: 125VAC/1A, 230VAC/1A, 30VDC/1A.

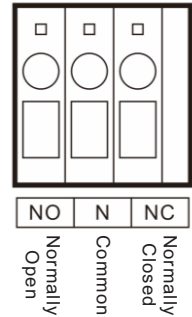

### 5.2 USB communication port

This is a USB communication port, which can be used for USB communication with the optional PC host software . To use this port, you should install the corresponding "USB to serial chip CH340T driver" and APP in the computer.

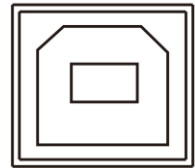

### 5.2 RS485 communication function

There are two communication ports RS485-1 and RS485-2 and also two functions:

- ① RS485 communication with lithium battery BMS can be conducted directly through this port RS485-2 (need to be customized);
- ② RS485-1 is connected to the selected RS485 to WiFi /GPRS communication module independently developed by our company After the selected module is equipped, the reverse control all-in-one machine of our company can be connected through mobile APP, and the operating parameters and status of the reverse control all-in-one machine can be checked through the mobile APP.
- ③ Such as shown in the figure: pin 1 is 5V power supply; pin 2 is GND, pin 7 is RS485-A and pin 8 is RS485-B.

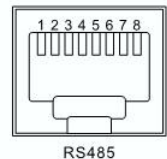



# MN5048DIY User Manual

## 6. Protection

### 6.1 Protections provided

No.	Protections	Description
1	PV current/power limiting protection	When charging current or power of the PV array configured exceeds the PV rating, it will charge at the rated value.
2	PV night reverse - current protection	At night, current is prevented from flowing back into the panels.
3	Mains input over voltage protection	When the mains voltage exceeds 280V (230V model) or 140V (120V model), the mains charging will stop and the unit will switch to inverter mode.
4	Mains input under voltage protection	When the mains voltage is lower than 170V (230V model /UPS mode ) or 90V (120V model or APL mode ), the mains charging will stop and the unit will switch to inverter mode.
5	Battery over voltage protection	When the battery voltage reaches the overvoltage disconnection point, the PV and the mains will automatically stop charging the battery to prevent damage to the battery from overcharging.
6	Battery low voltage protection	When the battery voltage reaches the low voltage threshold, the unit will stop inverting to prevent damage to the batteries from being over discharged.
7	Load output short circuit protection	When a short-circuit fault occurs at the load output terminal , the AC output is immediately turned off and turned on again after 1 second .
8	Heat sink over temperature protection	When the internal temperature is too high, the unit will stop charging and discharging; when the temperature returns to normal, charging and discharging will resume.
9	Overload protection	When an overload occurs, the unit will immediately stop the AC output. The unit will try again after three minutes. After five tries, the unit won't try again until the unit is powered down and restarted. Refer to the technical parameters table for information on settings.



# MN5048DIY User Manual

---

10	PV reverse polarity protection	When the PV polarity is reversed, the unit will not be damaged.
11	AC reverse protection	Prevents the inverter output from backfeeding into the AC input.





# MN5048DIY User Manual

## 6.2 Fault code meaning

Fault code	Fault name	Output Affected?	Description
【01】	BatVoltLow	Yes	Battery undervoltage alarm
【02】	BatOverCurrSw	Yes	Battery discharge average current overcurrent software protection
【03】	BatOpen	Yes	Battery not -connected alarm
【04】	BatLowEod	Yes	Battery undervoltage stop discharge alarm
【05】	BatOverCurrHw	Yes	Battery overcurrent hardware protection
【06】	BatOverVolt	Yes	Charging overvoltage protection
【07】	BusOverVoltHw	Yes	Bus overvoltage hardware protection
【08】	BusOverVoltSw	Yes	Bus overvoltage software protection
【09】	PvVoltHigh	No	PV over voltage protection
【10】	PvBuckOCSw	No	Buck overcurrent software protection
【11】	PvBuckOCHw	No	Buck overcurrent hardware protection
【12】	bLineLoss	No	Mains power down
【13】	OverloadBypass	Yes	Bypass overload protection
【14】	OverloadInverter	Yes	Inverter overload protection
【15】	AcOverCurrHw	Yes	Inverter overcurrent hardware protection
【17】	InvShort	Yes	Inverter short circuit protection
【19】	OverTemperMppt	No	Buck heatsink over temperature protection
【20】	OverTemperInv	Yes	Inverter heatsink over temperature protection
【21】	FanFail	Yes	Fan failure
【22】	EEPROM	Yes	Memory failure
【23】	ModelNumErr	Yes	Model setting error
【26】	RlyShort	Yes	Inverted AC Output Backfeed to Bypass AC Input
【29】	BusVoltLow	Yes	Bus Undervoltage Protection



# MN5048DIY User Manual

## 6.3 Troubleshooting

Faults	Handling measures
No display on the screen	Check if the battery circuit breaker or the PV circuit breaker are closed; if the switch is in the "ON" state; press any button on the screen to exit the screen sleep mode.
Battery overvoltage protection	Measure if the battery voltage exceeds rating, and turn off the PV array and Mains circuit breakers.
Battery undervoltage protection	Charge the battery until it returns to the low voltage disconnection recovery voltage.
Fan failure	Check if the fan is not turning or blocked by foreign objects.
Heat sink over temperature protection	When the temperature of the device is cooled below the recovery temperature, normal charge and discharge control will resume.
Bypass overload protection, inverter overload protection	<ul style="list-style-type: none"> <li>① Reduce the use of power equipment;</li> <li>② Restart the unit to resume load output.</li> </ul>
Inverter short circuit protection	<ul style="list-style-type: none"> <li>① Check the load connection carefully and clear any short circuit faults.</li> <li>② Re-power up to resume load output.</li> </ul>
PV overvoltage	Use a multimeter to check if the PV input voltage exceeds the maximum allowable input voltage rated .
Battery missing alarm	Check if the battery is not connected or if the battery circuit breaker is not closed.



# MN5048DIY User Manual

---

## 7. System maintenance

- > In order to maintain the best long-term performance, it is recommended to conduct the following checks twice a year.
1. Make sure that the airflow around the unit is not blocked and remove any dirt or debris from the heat sink.
  2. Check that all exposed wires are not damaged by exposure to sunlight, friction with other objects around them, dryness, damage by insects or rodents, etc., repair or replace if necessary.
  3. Verify the consistency of indication and display with the operation of the device. Please pay attention to the display of any faults or errors, and take corrective actions as necessary.
  4. Check all wiring terminals for corrosion, insulation damage, signs of high temperature or burning/discoloration, and tighten the screws.
  5. Check for dirt, nesting insects and corrosion, and clean up as required.
  6. If the surge suppressor has failed, replace in time to prevent lightning damage to the unit or other equipment.

Warning: Danger of electric shock! When doing the above operations, make sure that all power supplies of the unit have been disconnected, and all capacitors have been discharged, and then then check or operate accordingly!

- > MidNite Solar AKA MNS does not assume any liability for damage caused by:
- ① Improper use or improper installation, or location. (exposed to the elements)
  - ② Open circuit voltage of the PV module exceeds the maximum allowable input voltage rating.
  - ③ Temperature in the operating environment exceeds the limited operating temperature range.
  - ④ Disassemble and repair of the MNS Hybrid Inverter without permission.
  - ⑤ Force majeure: Damage that occurs in transportation or handling of the MNS Hybrid Inverter.



# MN5048DIY User Manual

## 8. Technical Parameter

Model	MN5048DIY
<b>AC mode</b>	
Rated input voltage	110/120Vac
Input voltage range	(90Vac-140Vac)
Frequency	50Hz/ 60Hz (auto-sensing)
Frequency range	47±0.3Hz~55±0.3Hz(50Hz); 57±0.3Hz~65±0.3Hz(60Hz);
Overload/short-circuit protection	Breaker
Efficiency	>95%
Conversion time	10ms(Typicalvalue)
(Bypass and inverting)	
AC reverse flowing protection	yes
Maximum bypass overload current	63A
<b>Inverting mode</b>	
Output voltage waveform	Pure sine wave
Rated output power(VA)	5000(4100/ 4300/4500)
Rated output power(W)	5000(4100/ 4300/4500)
Power factor	1
Rated output voltage(Vac)	120Vac(100/105/110Vac Settable)
Output voltage error	±5%
Output frequency range(Hz)	50Hz±0.3Hz 60Hz±0.3Hz
Efficiency	>90%
Overload protection	(102%<load<110%) ±10%: reporting error and turn off the output after 5 minutes; (110%<load<125%) ±10%: reporting error and turn off the output after 10 seconds; Load>125% ±10%: reporting error and turn off the output after 5 seconds;



# MN5048DIY User Manual

Peak power	10000VA
Loaded motor capacity	4HP
Output short-circuit protection	Breaker
Specification of bypass breaker	63A
Rated battery input voltage	48V (minimum start voltage 44V)
Battery voltage range	40.0Vdc~60Vdc $\pm$ 0.6Vdc (undervoltage alarm/turnoff voltage/overvoltage alarm/overvoltage restoration...settable LCDscreen)
Power saving mode	Load $\leq$ 50W
<b>AC charge</b>	
Battery type	Lead acid or lithium battery
Maximum charge current	40A
Charge current error	$\pm$ 5A <sub>dc</sub>
Charge voltage range	40~60V <sub>dc</sub>
Breaker specification	63A
Overcharge protection	Turn off charge after 1min alarm
<b>Solar charge</b>	
Maximum PV open-circuit voltage	500V <sub>dc</sub>
PV operation voltage range	120-500V <sub>dc</sub>
MPPT voltage range	120-450V <sub>dc</sub>
Battery voltage range	40-60V <sub>dc</sub>
Maximum output power	5000W
Charge current range of solar energy(settable)	0-80A
Charge short-circuit protection	Blown fuse
Wiring protection	Inverse wiring protection



# MN5048DIY User Manual

<b>Authentication specification</b>	
Specification authentication	CE(IEC62109)、RoHs
EMC authentication grade	En61000
Operation temperaturerange	-15°Cto55°C
Storage temperaturerange	-25°C~60°C
Humidity range	5% to 95% (three-proof paint protection)
Noise	≤60dB
Thermal dissipation	Forced cooling with adjustable air speed
Communication interface	USB/RS485(WiFi/GPRS)/dry node control
Dimension(L*W*D)	426mm*322mm*126mm
Weight(kg)	11.6



# MN5048DIY User Manual

## MIDNITE SOLAR INC. LIMITED WARRANTY

MidNite Solar DIY inverters, DIY sheet metal enclosures, DIY breaker boxes and DIY accessories

MidNite Solar Inc. warrants to the original customer that its products shall be free from defects in materials and workmanship. This warranty will be valid for a period of ONE (1) year for all DIY series inverters, DIY sheet metal enclosures, DIY breaker boxes and DIY accessories.

At its option, MidNite Solar will repair or replace at no charge any MidNite product that proves to be defective within such warranty period. This warranty shall not apply if the MidNite Solar product has been damaged by unreasonable use, accident, negligence, service or modification by anyone other than MidNite Solar, or by any other causes unrelated to materials and workmanship. The original consumer purchaser must retain original purchase receipt for proof of purchase as a condition precedent to warranty coverage. To receive in-warranty service, the defective product must be received no later than two (2) weeks after the end of the warranty period. The product must be accompanied by proof of purchase and Return Authorization (RA) number issued by MidNite Solar.

For an RMA number contact MidNite Solar Inc., (360) 403-7207. Purchasers must prepay all delivery costs or shipping charges to return any defective MidNite Solar product under this warranty policy. Except for the warranty that the products are made in accordance with, the specifications therefore supplied or agreed to by customer:

MIDNITE SOLAR MAKES NO WARRANTY EXPRESSED OR IMPLIED, AND ANY IMPLIED WARRANTY OF MERCHANTABILITY OR FITNESS FOR A PARTICULAR PURPOSE WHICH EXCEEDS THE FOREGOING WARRANTY IS HEREBY DISCLAIMED BY MIDNITE SOLAR AND EXCLUDED FROM ANY AGREEMENT MADE BY ACCEPTANCE OF ANY ORDER PURSUANT TO THIS QUOTATION. MIDNITE SOLAR WILL NOT BE LIABLE FOR ANY CONSEQUENTIAL DAMAGES, LOSS OR EXPENSE ARISING IN CONNECTION WITH THE USE OF OR THE INABILITY TO USE ITS GOODS FOR ANY PURPOSE WHATSOEVER. MIDNITE SOLAR'S MAXIMUM LIABILITY SHALL NOT IN ANY CASE EXCEED THE CONTRACT PRICE FOR THE GOODS CLAIMED TO BE DEFECTIVE OR UNSUITABLE.

Products will be considered accepted by customer unless written notice to the contrary is given to MidNite Solar within ten (10) days of such delivery to customer. MIDNITE SOLAR is not responsible for loss or damage to products owned by customer and located on MIDNITE SOLAR'S premises caused by fire or other casualties beyond MIDNITE SOLAR'S control. This warranty is in lieu of all other warranties expressed or implied.

MIDNITE SOLAR INC. Email: [info@midnitesolar.com](mailto:info@midnitesolar.com)  
PH: 360-403-7207 FAX: 360-691-6862